

OMAC



monobloc lobe pumps BE series



AUT. N° 810

STANDARD VERSION

The BE SERIES Lobe Pumps derives from the well-known B series pump since it shares several of its characteristics. The AISI 316 L stainless steel pump is assembled on a cast iron gear box which has a protective coating in epoxy paint finish. The chamber separating the pump body and gear box avoids any contamination between the pumped fluid and the lubricant.

The BE series pumps are simple and robust and are characterised by their monobloc design. The drive unit, thanks to the hollow shaft and to the rear cover provided with an IEC flange, is directly fixed to the pump by creating a unique compact and light body.

The new design, with smooth cover and fixing nut built in the rotors, improves the cleaning (CIP) and sterilisation (SIP) standard.



The lobe pumps of this series are provided only with bi-lobe rotary piston rotors, in AISI 316 stainless steel or in antifriction alloy Acteon, which ensure an excellent volumetric efficiency and a smooth and regular transfer of several liquid or viscous products.

The bi-lobe rotary piston rotors have big chambers that close twice per revolution and make these pumps suitable for transferring fluids containing solids in suspension, from 10 mm. for the BE 115 model to 19 mm. for the BE 440 model.

Also in the BE series, the main parts (rotors, seals) and the optional parts can be added or changed according to different utilisation requirements. The wide range of available seals and gaskets (similar to those of the B series) allows an excellent choice according to the characteristics of the transferred product.

In less demanding works, the BE pumps can replace the B pumps and, meeting the increasing demand of cheap lobe pumps with a high sanitary standard, allow to widen the utilisation possibilities of the OMAC pumps.



SPECIAL VERSIONS

HEATED JACKET BODY



If it is necessary to keep the pumped fluid at a constant temperature a heated jacket body is available for all the pumps. This allows the circulation of heating or cooling liquid. Typical examples are melted fats, butter and margarine, chocolate and glucose. On request the heated jacket

front cover can be made available and it's own or with heated jacket on the body.

ENLARGED SUCTION INLET



The BE115, BE220, BE330, BE440 Models can be supplied with enlarged rectangular suction inlets allowing highly viscous products such as semi-solid pieces to be pumped. In these cases the pump is generally positioned with the port on a vertical axis in order to allow the entry

of the product under gravity directly beneath the hopper.

PRESSURE RELIEF VALVE SYSTEMS



Integral pressure relief valve

The pumps can be supplied on request with hygienic by-pass or pressure relief valves. This device protects the pump from pressure peaks or restrictions in the discharge and assures excess liquid deviation during CIP and SIP. The relief valve can be manually selected as a flow regulator in order to pass product allowing the pump can be run continuously. This valve can be incorporated in the end cover that replace the standard cover, providing a pressure relief valve loop from discharge to the suction area; alternatively it can be incorporated in the discharge pipework, relieving excess pressure by by-passing product through a loop back to the suction side. The integral relief valve is

suitable for CIP process line and functions for either direction of flow. The external pressure relief valve (unidirectional) can be assembled in order to recycle the whole pumped product. This valve is especially suitable for frequently operations and for volatile, heat or shear sensitive product. For both of the valves a manual, pneumatic or automatic operation is available.



External pressure relief valve

MOUNTING AND DRIVES



The new OMAC pumps can be supplied either bare shaft or complete with directly flanged drive unit. The pump unit becomes very compact without bare rotation shafts and with minimum dirt-collecting surfaces. Trolleys and such accessories as feet for vertical connections, adjustable feet, and stainless steel shrouds covering the motors can also be supplied as to build pumping sets which exactly satisfy customer's requirements. Power transmission can be variable speed via mechanical, hydraulic, belt adjustable speed unit or inverter integrated into the motor; alternatively can be fixed speed via reduction geared motor. For controlling the pumps the options are various and these include on off reversing switch, IP65 inverter, electric panel with IP21 inverter for remote control signal.

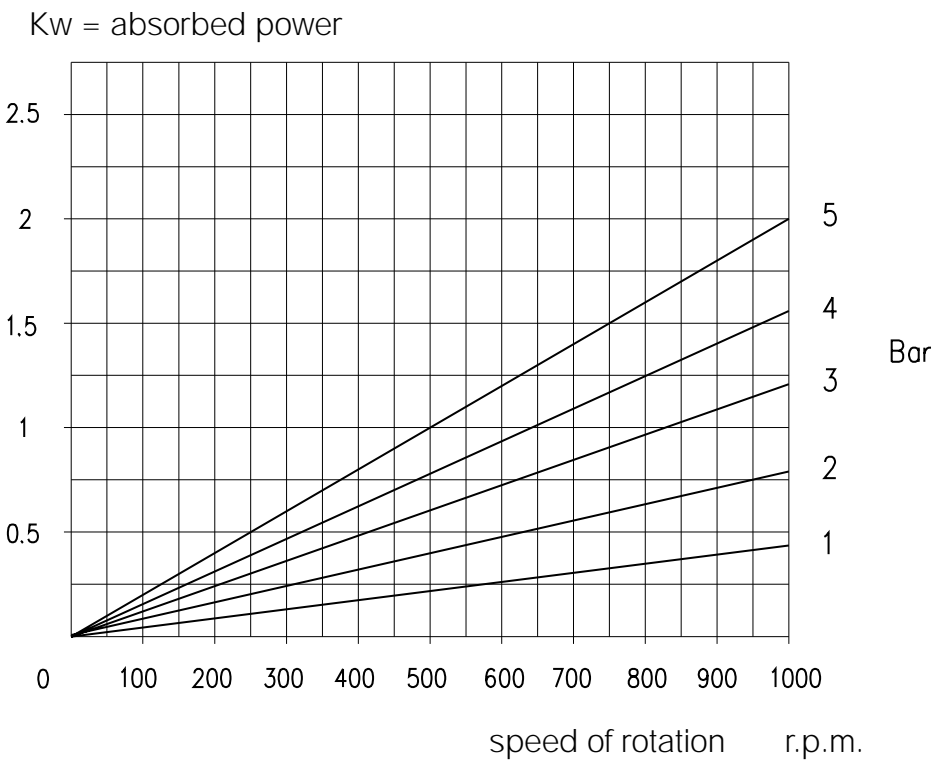
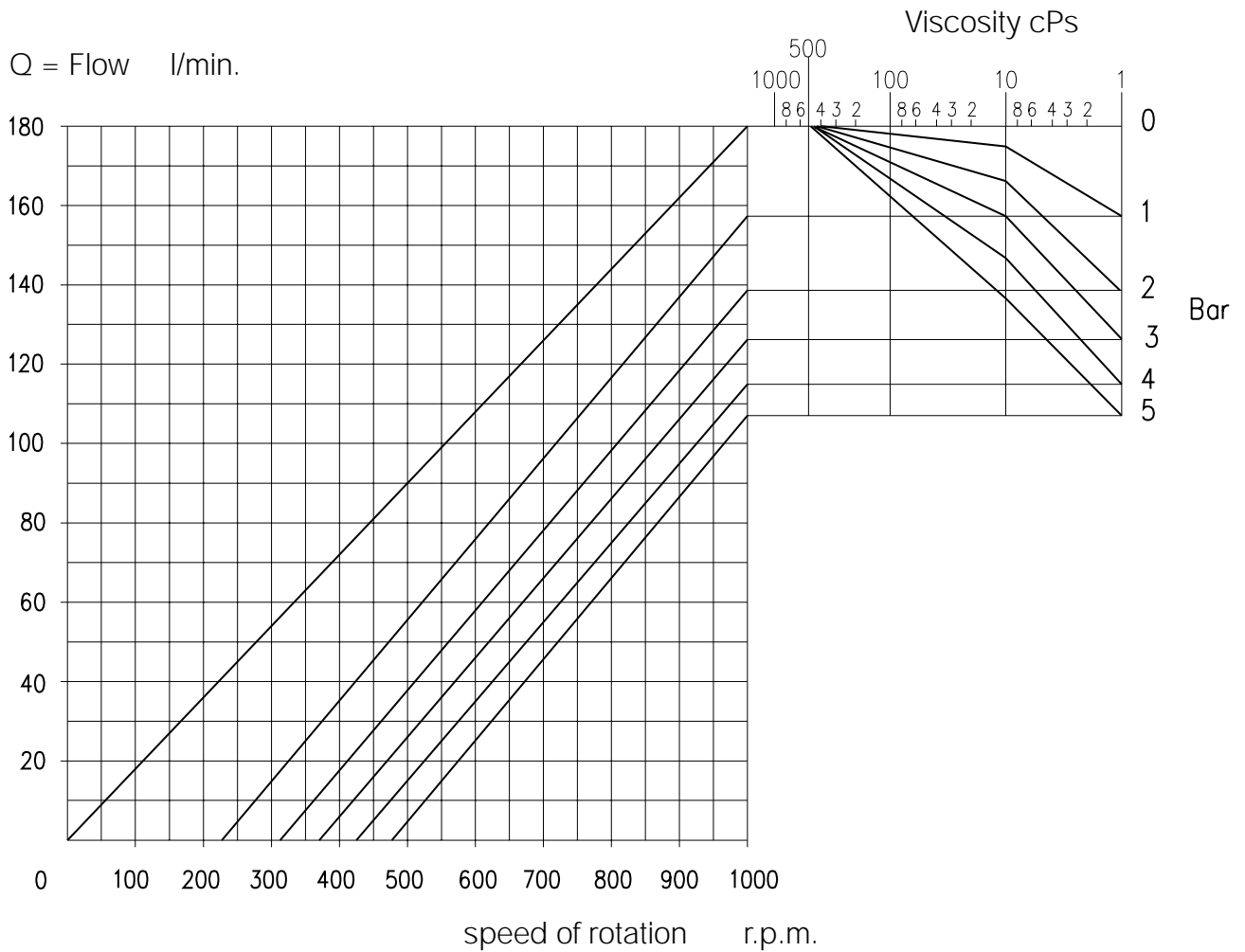

Q = Flow l/min.

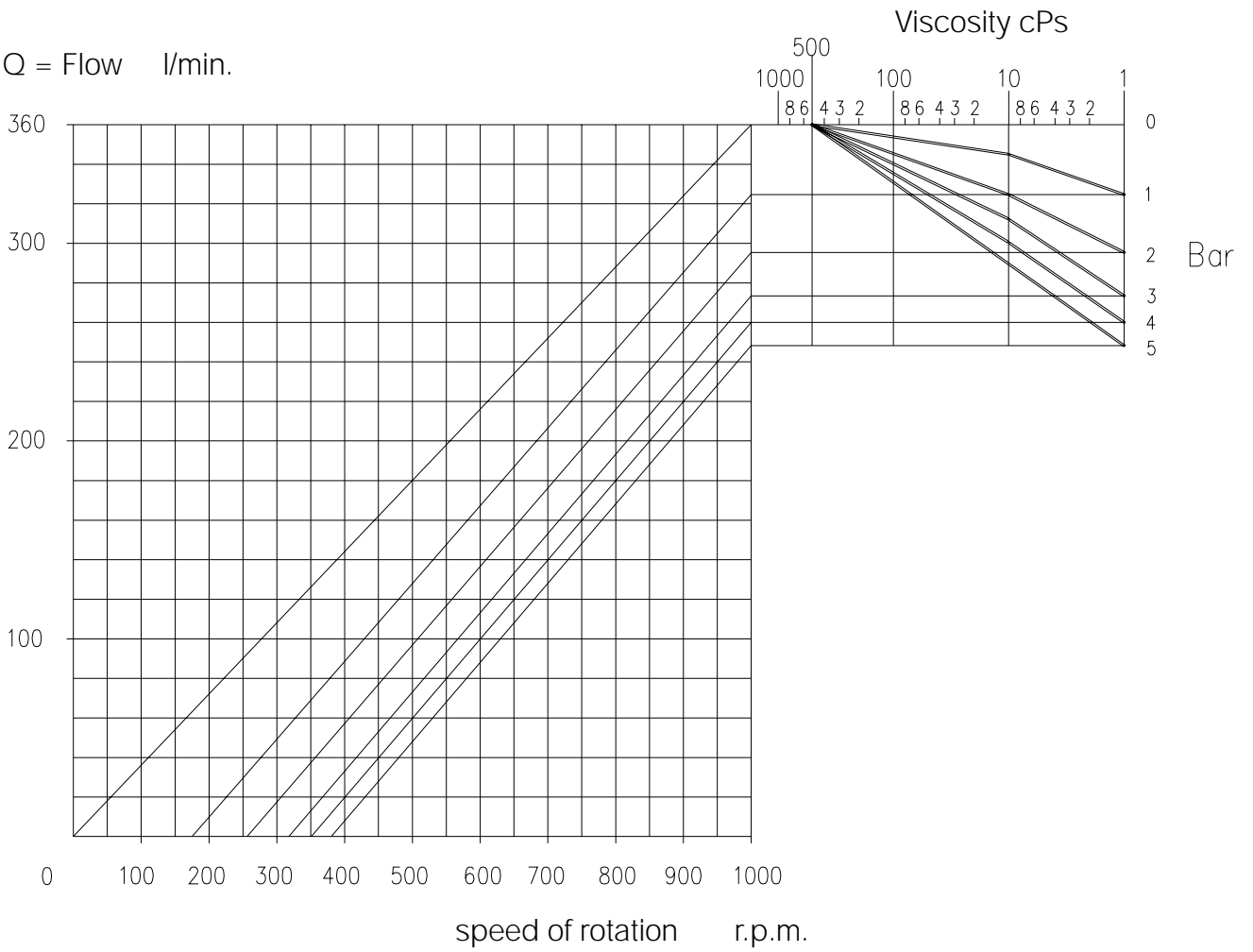

Kw = absorbed power

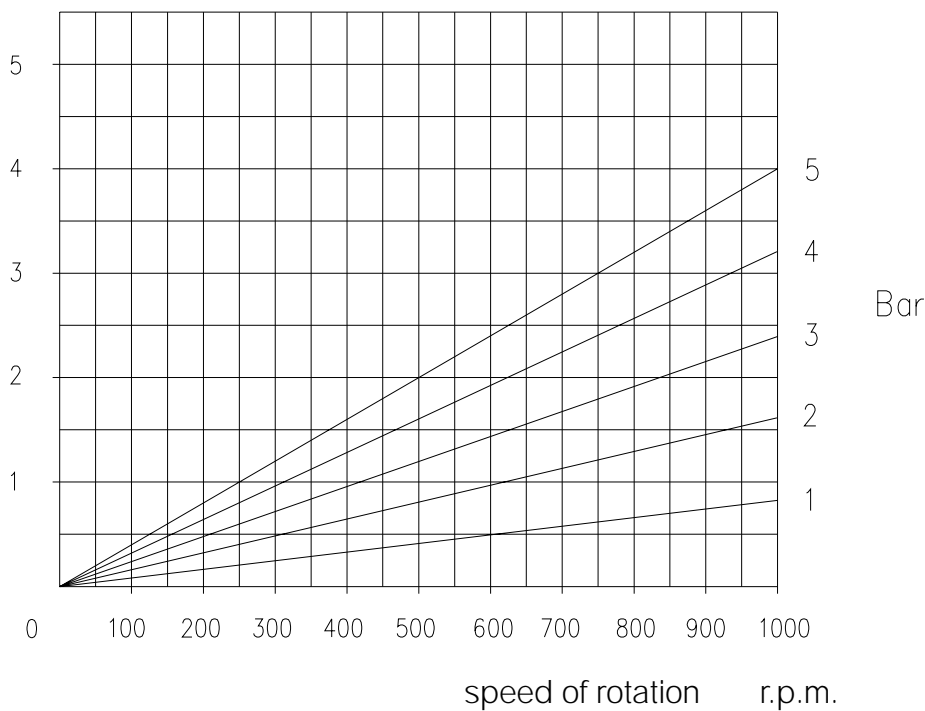

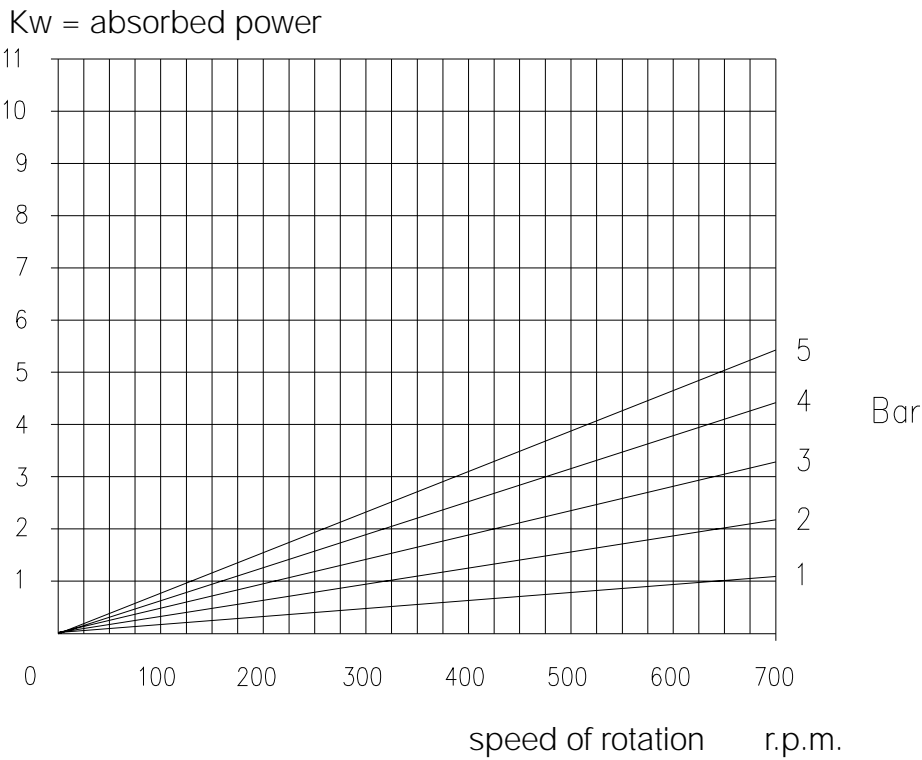
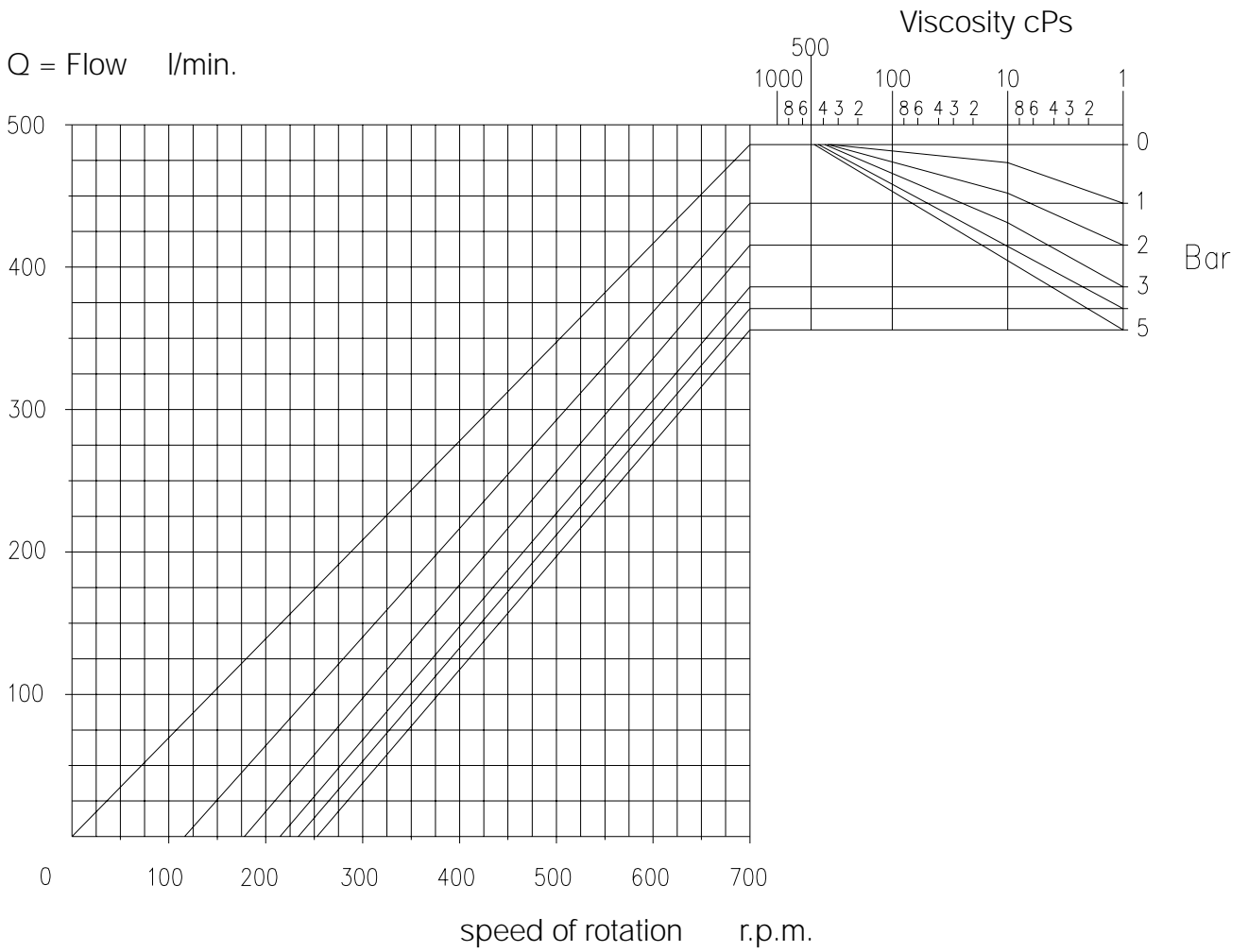

Q = Flow l/min.

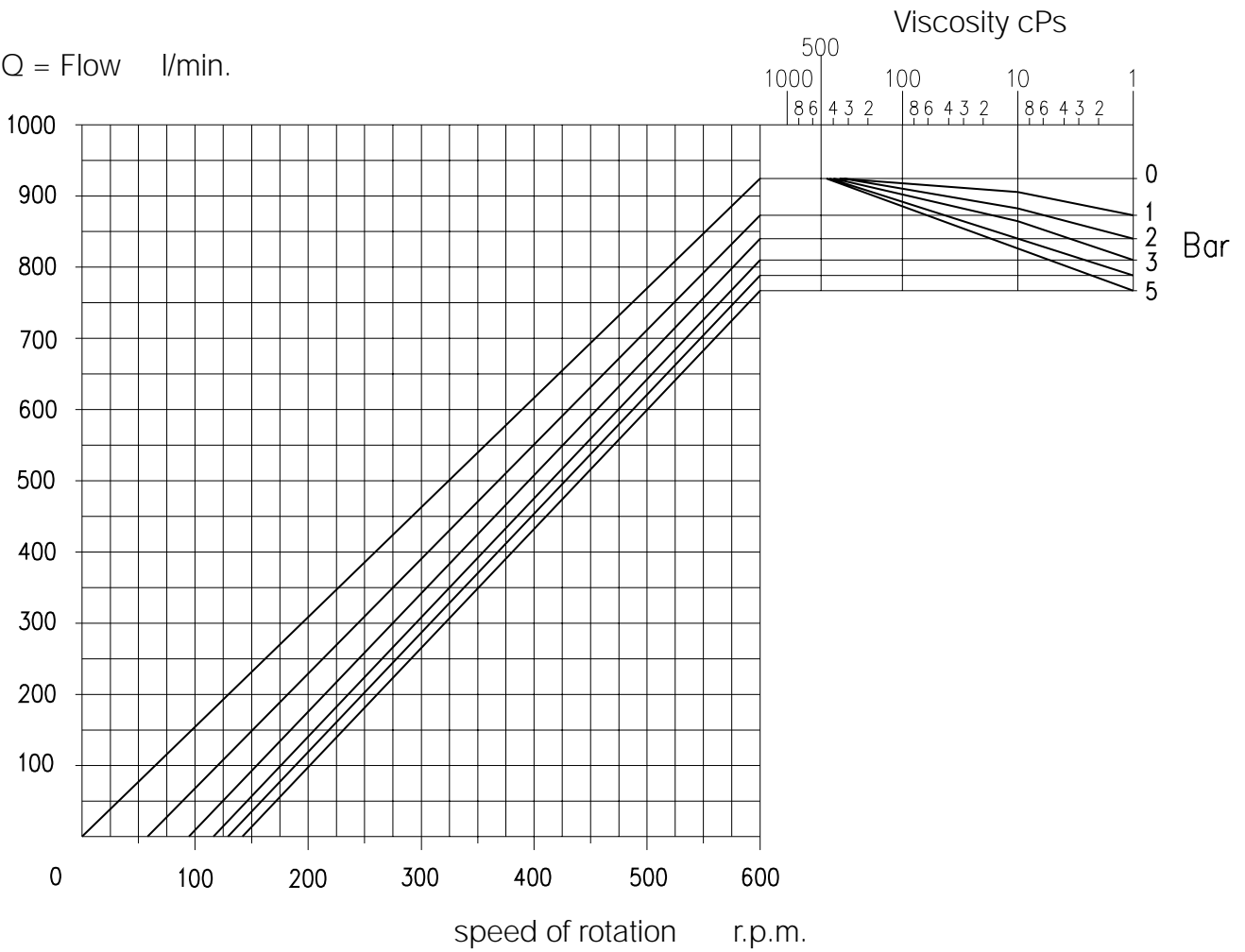

Kw = absorbed power

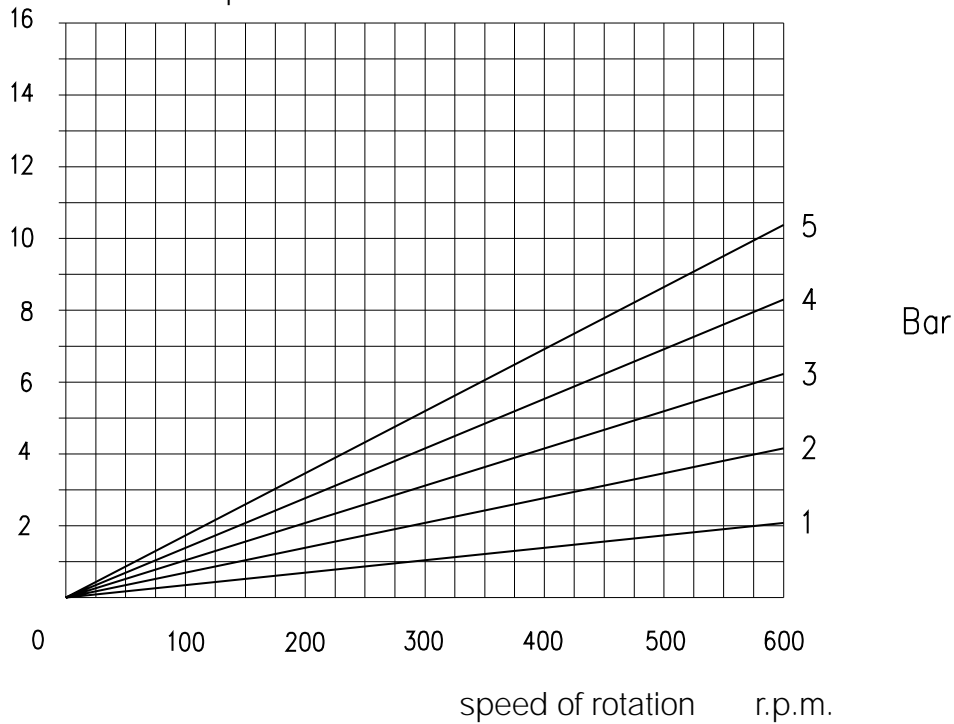

TECHNICAL DATA

HYDRAULIC TECHNICAL DATA

PUMP SIZE	VOLUMETRIC FLOW l/100 rev.	MAX SPEED r.p.m.	MAX POWER KW	MAX POWER Bar	FITTINGS					
					GAS BSP	DIN 11851	SMS	OENOLOGICAL	RJT	TRI CLAMP
BE115	18	1000	2,2	5	1"1/2	40	38,1	40	38,1	38,1
BE220	34	950	4	5	2"	50	50,8	50	50,8	50,8
BE330	70	700	5,5	5	3"	80	76,2	80	76,2	76,2
BE440	155	600	9,2	5	4"	100	101,6	100	101,6	101,6

SOME PUMPED PRODUCTS

vinegar	ketchup	tomato purée
distilled water	milk	diced tomaatoes
hydrogen peroxide	condensed milk	perfumes
alcohol	latex	mashed potato
adhesives	yeast	fruit purée
beer	liquor	brine
soup	lotions	saucuses
melted butter	mayonnaise	blood
curd	malt	soap
mincemeat	melted margarine	syруп
chocolate	jam	shampoo
glue	marzipan	caustic soda
cream	molasses	galvanic solution
toothpaste	mushroom	sugar solution
detergents	honey	solvents
emulsions	coconut oil	fruit juice
explosives	olive oil	tea
essences	baby food	surfactants for
milk enzymes	sponge-cake	detergents
strawberries	cream	tointment
ice-cream	paraffin	eggs
gelatine	suppository	vaseline
icing	paste	paint
glycerine	hand cleaning	wine
glucose	paste	yoghurt
animal grease	polymers	
	fruit pulp	

INDUSTRIAL APPLICATIONS

COSMETICS:	beauty creams, toothpaste, shampoo, detergents, lotions
CHEMICAL:	paints, enamels, detergents, polymers, resins, dodecylbenzene, acids, etc.
BEVERAGES:	wine, alcohol, beer, soft drinks, syrup, tea, fruit juice, grape juice, mineral water
FOOD:	fruit and tomato concentrates, fruit and vegetable salads, preserved vegetables, sauces, mayonnaise, homogenized meat, starch, vegetable purées, etc.
CONFECTIONERY:	chocolate, cream, sponge-cake, products with yeast, fillings, fats, margarine, jam, marmalade
DAIRY:	milk and its products, soft cheese, yoghurt, fruit for yoghurt, butter, curd, cream, whey, etc.

OVERALL DIMENSIONS IN MM.

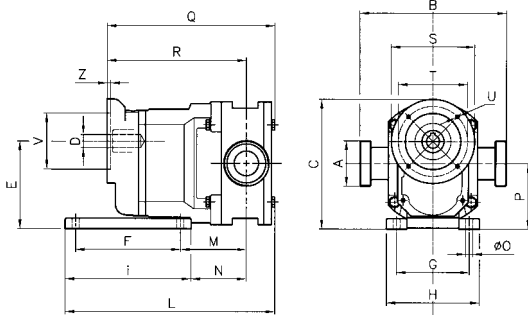

TYPE OF PUMP WITH GAS-BSP PORTS	POS.																	KG.				
	A	B	C	D	E	F	G	H	I	L	M	N	O	P	Q	R	S		T	U	V	Z
BE115-F1	1"1/2	170	185	19	125	150	105	134	180	300	94	79	10	93,5	240	199	120	100	M6 (8)	80	5	21
BE115-F2				20													120	100	M6 (8)	80		
BE115-F3			285	19											265	213	200	165	M10 (4)	130	4	
BE115-F4			285	24											265	213	200	165	M10 (4)	130	4	
BE220-F1	2"	208	245	25	165	170	125	160	200	357	119	104	12	127,5	307,5	256	160	130	M8 (4)	110	5	43
BE220-F2			290	28											324	272,5	250	215	M12 (4)	180		
BE330-F1	3"	236	290	30	190	200	140	180	240	438	151	131	14	145	384	339	200	165	M10 (4)	130	5	65
BE330-F2			315	28											396	351	250	215	M12 (4)	180		
BE440-F1	4"	335	355	30	255	250	190	240	300	523,5	157,5	132,5	18	192,5	450,5	367,5	200	165	M10 (4)	130	5	135
BE440-F2			405	48											470,5	387,5	300	265	M12 (4)	230		

PUMPS WITH PORTS:

TYPE OF PUMP	UNI2278 PN16 FLANGED PORTS		DIN 11851		SMS		IDF-ISS		RJT		TRI-CLAMP	
	A	B	A	B	A	B	A	B	A	B	A	B
BE115	DN40	186	DN40	210	DN40	210	DN40	210	DN40	210	DN40	210
BE120	DN50	228	DN50	228	DN50	248	DN50	248	DN50	248	DN50	248
BE330	DN80	256	DN80	296	DN80	296	DN80	286	DN80	290	DN80	290
BE440	DN100	355	DN100	395	DN100	395	DN100	389	DN100	392	DN100	389

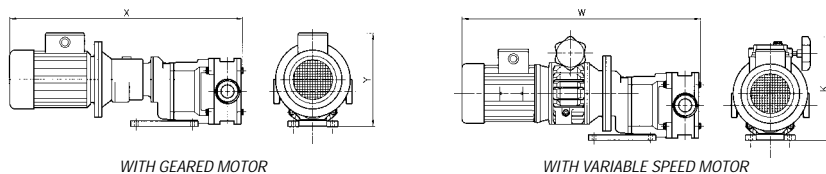

TYPE OF PUMP	BE 115				BE 220				BE 330				BE440										
	DIMENSIONS*												X	Y	W	K							
POWER KW	0,75	651	240	636	277																		
	1,1	701	274	706	311	773	286	765	351														
	1,5					773	286	765	351														
	2,2					793	303	872	384	882	328	944	409										
	3									882	328	944	409										
	4									882	349	944	409	949	393	1019	474						
	5,5													1090	430	1139	521						
	7,5													1090	430	1139	521						
9,2													1090	430	1139	521							

* Approximate dimensions to confirm according to available drives

DEALER



www.flowcomm.nl
+31-318 582690



OMAC S.r.l POMPE Via G. Falcone, 8 - 42048 RUBIERA (RE) - ITALY
TEL. 0522 629371-629923 - FAX 0522 628980
www.omacpompe.com - E-mail: info@omacpompe.com